



CONÉCTALA A
STRUGAL HOME
CONNECT IT TO
STRUGAL HOME



Una solución innovadora que unifica todos los elementos de tu vivienda.

An innovative solution that brings harmony to every part of your home.



Visita la web y descubre todas las novedades. See what's new: visit our website.

amazon alexa | Google Home



La **STRUGAL S140RP INFINITY** corredera minimalista de altas prestaciones, que permite hojas de hasta **7,5 m², 300 kg** y acristalamientos de **12mm o 32mm**.

Destaca por su excelente estanqueidad, resistencia al viento y aislamiento, ofreciendo confort y eficiencia en grandes aperturas con diseño elegante.

The **STRUGAL S140RP INFINITY** is a minimalist, high-performance sliding system that allows sashes of up to **7.5 m², 300 kg** and glazing thicknesses of **12 mm or 32 mm**. It stands out for its exceptional water tightness, wind resistance, and thermal and acoustic insulation, offering comfort and efficiency in large openings with an elegant design.

Dimensiones
Máximas hoja
Maximum dimensions
per sash **2,6 x 3,2 m**

Peso máximo
por hoja
Maximum weight
per sash **300 kg**

Acristalamiento
Glazing **12/32 mm**

CLASE 3 **7A** **C5**

U_f ≥ 2,6 W/m²K* **≤ 42 dB**
U_w ≥ 0,8 W/m²K**

*Consultar transmittancias de los diferentes nudos. **Consultar tipologías, dimensiones y vidrios.

CERRADURA ALTA SEGURIDAD
High security lock



Cilindro europerfil con pomo y multipunto palanca gancho
Europrofile cylinder with knob and multipoint hook lever

APERTURAS
OPENINGS

2 carriles
2 tracks

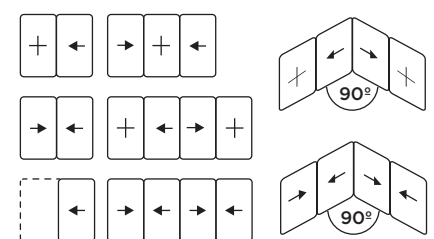

3 carriles
3 tracks

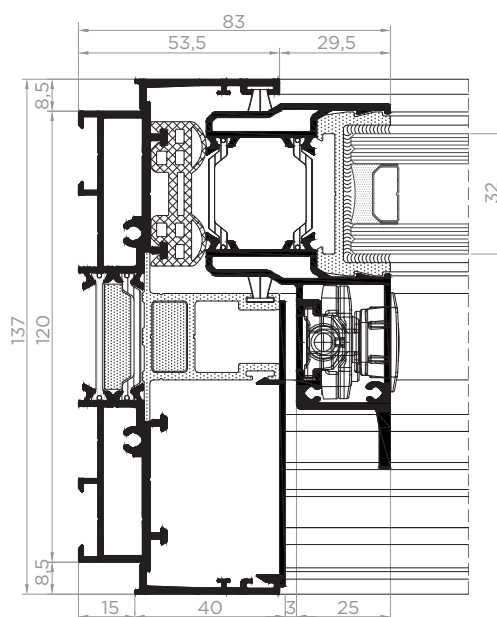
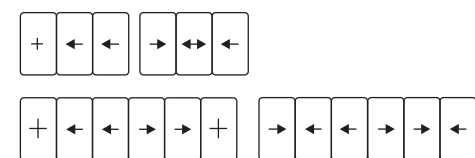

1:2

ASPECTOS DESTACADOS

KEY FEATURES

Correderas diseñadas para maximizar la luz, la amplitud y la integración en cada espacio

Sliding systems designed to maximize light, openness, and seamless integration in every space

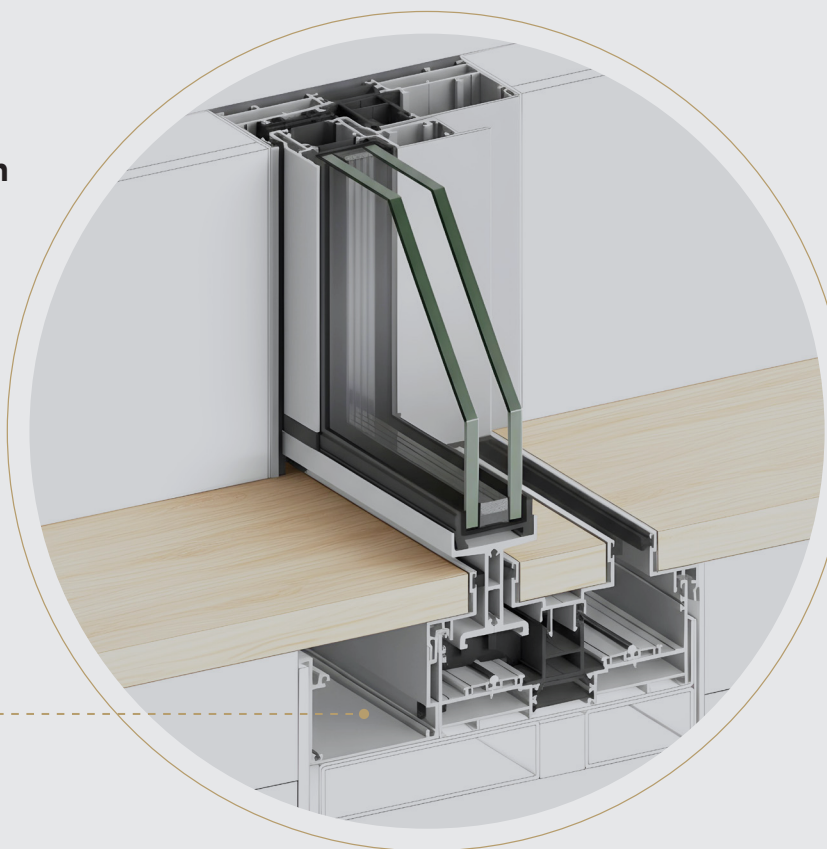

Opción canaleta de desagüe
Gutter option for drainage

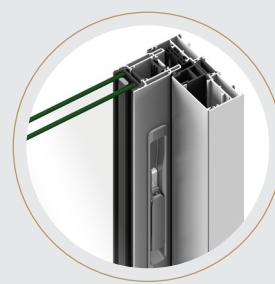

CIERRE MULTIPUNTO
Multipoint lock

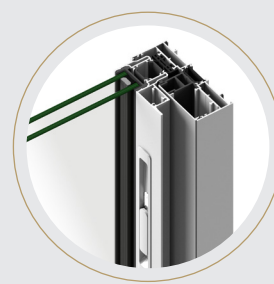

HOJA REDUCIDA
Reduced sash

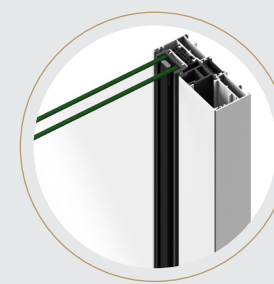

HOJA OCULTA
Hidden sash

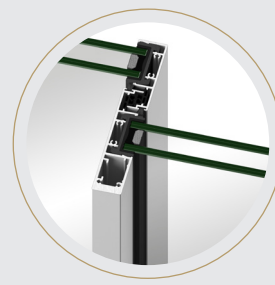

NUDO CENTRAL MÍNIMO
Minimum central node

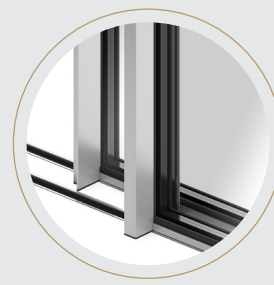

SOLERÍA PASANTE
Flush flooring system

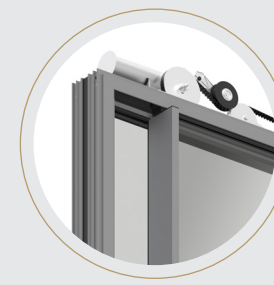

MOTORIZADA
Motorized

DISEÑO PERSONALIZADO

CUSTOM DESIGN

Soluciones para la arquitectura, el diseño y el interiorismo

Inspiring solutions for architecture, design, and interiors



MANILLA ENRASADA TITÁN
Flush handle



MANILLA TIRADOR MINIMALISTA
Minimalist pull handle



MANILLA ENRASADA TITÁN MAX
Max Flush Handle

MANILLA TIRADOR TITÁN FLAP
Titan handle puller



TIRADOR MINIMALISTA
Minimalist handle

STRUGAL

STRUGAL

STRUGAL



Sistema deslizante de última generación para ventanas y puertas, con una estética ultraminimalista gracias a su nudo central de solo 25 mm y perfiles horizontales ocultos.

Next-generation sliding system for windows and doors, featuring an ultra-minimalist design with a central joint of just 25 mm and concealed horizontal profiles.



ST

www.strugal.com
f @ in



STRUGAL
S140RP INFINITY

Cuando el minimalismo conquista el espacio

When minimalism takes over your space

La corredera minimalista STRUGAL S140RP INFINITY permite grandes aperturas realizando el espacio con una estética depurada y funcional. Diseñada para potenciar la continuidad visual y la conexión entre interior y exterior, ofrece un equilibrio perfecto entre elegancia, eficiencia y confort.

The STRUGAL S140RP INFINITY minimalist sliding system transforms wide openings, bringing a refined, functional aesthetic to your home. Designed to maximize seamless visual flow and strengthen the connection between indoors and outdoors, it delivers the perfect harmony of elegance, efficiency, and comfort.

STRUGAL